

PRODUCT CATALOG

CMP
CMP Group Ltd.



PANTHER[™]



*TROLL***Master**[™]



For over three decades, **Panther Marine Products** has been a leading supplier of high-quality marine equipment. Our history as a top seller of trim and tilts, Safe-Skeg, outboard motor brackets, and oil extractors demonstrates our commitment to excellence.

Since 2020, as a part of the CMP Group, we continue to prioritize quality, product development, and customer service. We offer an extensive range of products, including steering solutions, security systems, anchoring solutions, ladders and other accessories.

Panther recently relaunched the **EZ-Steer Universal** demonstrating our dedication to continuous product development. We are committed to providing reliable products and exceptional support to our valued distributors and dealers.

Discover the ultimate boating and fishing experience with Panther Marine Products, including **TrollMaster** steering and **EZ-Steer Universal** Auxiliary Motor steering control brands.

Designed for boaters, weekend enthusiasts, and passionate anglers, our solutions enhance your time on the water. Dive into a world of convenience, safety, and unparalleled performance with our trusted marine products, perfect for maximizing your pleasure on the water.



CMP Group Ltd.

7733 Progress Way

Delta, BC, V4G 1A3, Canada

Tel: 1-877-938-9766 | Fax: 1-604-952-2650

cmpgroup.net

CONTENTS

Steering & Controls	4
Panther XPS G2.....	5
Panther XPS G2 Accessories.....	6
TrollMaster ProAngler	7
TrollMaster Pro Wired	8
Servo Hardware Kits.....	8
EZ-Steer Universal	9
Panther Kicker Steering	10
Tie Bar Kits	11
Wireless Remote Control.....	11
Outboard Motor Hardware	12
Swim Platform Outboard Motor Bracket.....	12
Fixed-Mount Outboard Motor Brackets	12
Motor Restraints & Safety	12
Adjustable Outboard Motor Brackets	13
Motor Lift/Set-Back Brackets	14
Outboard Motor Support for Trailering	15
Trim and Tilt	16
Accessories	17
Security Systems	18
Lower Unit Locks.....	18
Outboard Locks	19
Anchoring & Mooring	20
King Pin Anchoring Systems.....	20
Anchoring & Mooring Accessories	22
Safe-Skeg	24
Deck Hardware & Mounts	26
Electronics Mounts.....	26
Recessed Foot-Control Tray.....	28
Multi-Mounts & Trolling mounts	28
Quick-Release Adapter	29
Spare Base Plates	29
Rod Holders	29
Accessories	30
Fluid Extractors	30
Engine Flushing & Maintenance	31
Trailering & Transport Support	32
Pontoon Accessories	33
Mounting Hardware	33
Service and Warranty	34



Meet the Panther Steering Family – Three Brands, Four Products, One Goal

At Panther Marine, we provide cutting-edge steering solutions tailored to meet the diverse needs of boaters. Our Steering & Controls lineup includes:

Panther XPS Power Steering – Hydraulic steering for those hard to turn cable steering applications.

TrollMaster – The go-to wireless throttle control system for precision trolling.

EZ-Steer – The ultimate auxiliary motor steering system for seamless transitions between main and kicker motors.

Panther Kicker Steering – Reliable electronic and mechanical steering solutions for auxiliary motors.

Together, these brands provide boaters and anglers with total control, whether you're making sharp turns, perfecting your trolling technique, or seamlessly switching between engines.

Take Command of the Water with Precision Steering Solutions

When it comes to steering control, precision is everything. Whether you're navigating tight channels, trolling at a precise speed, or switching between your main and kicker motor, Panther Marine's cutting-edge steering systems ensure smooth, responsive control every time. Whether you're a tournament angler or a weekend warrior, Panther's steering solutions put power at your fingertips.

PANTHER XPS G2

The Ultimate Upgrade

Engineered to make steering your boat as effortless as the vehicle you drive. No matter the vessel you operate, XPS offers affordability, confidence, fit and all around ease of operation.

Experience next-level maneuverability with the Panther XPS Gen 2 Power Steering System. Designed to take the strain out of steering, this high-performance system offers effortless control, making it ideal for long days on the water.

Precision Handling: Provides smooth, hydraulic-assisted steering for outboard motors.

Torque Reduction: Eliminates torque feedback and reduces operator fatigue, making handling large boats easier.

Adaptable Fit: Available with various hose kits and universal mount plate for seamless installation.

Built for Performance: Engineered for both freshwater and saltwater environments, ensuring adaptable long-lasting durability.

Part ID: 109700

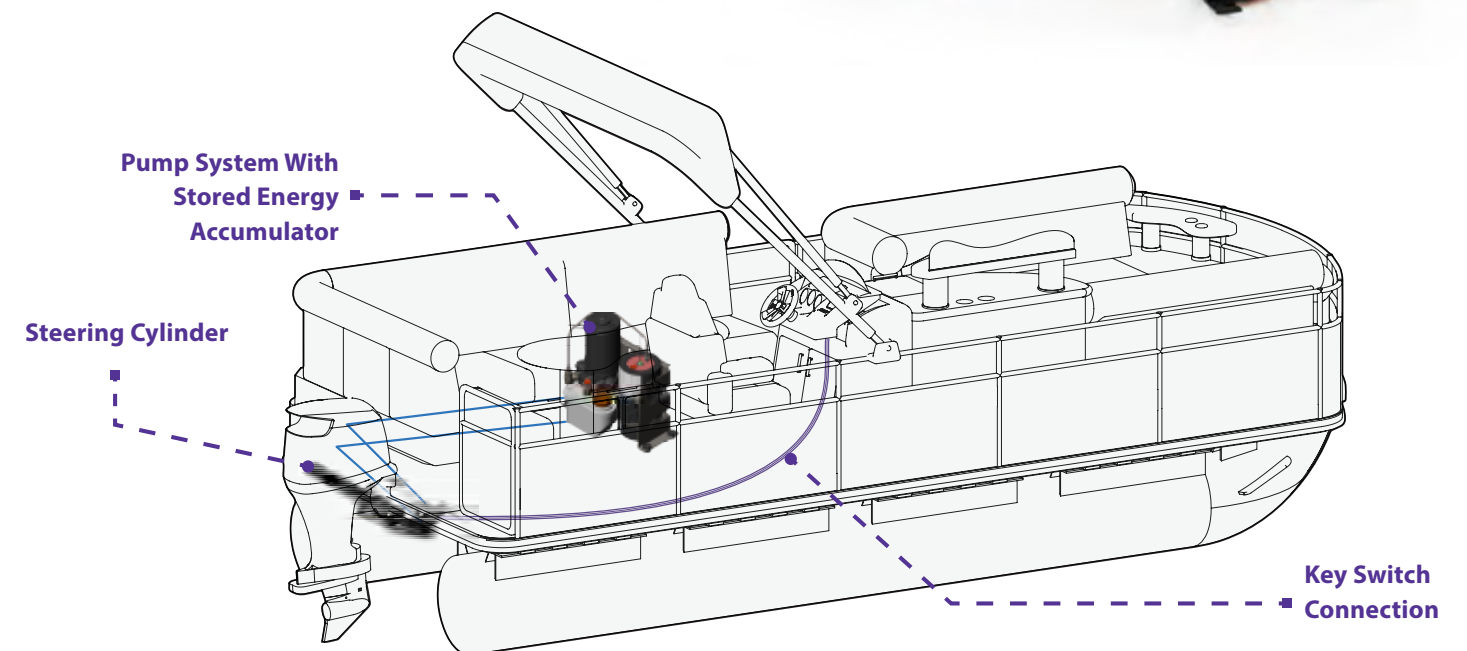

PANTHER XPS G2 ACCESSORIES

Hose Kits

Multiple hose lengths are available so you can custom fit the Panther XPS System to your boat.

Part ID	High Pressure Hose (1/4")	Return Hose (5/16")
106106	6'	7'
106107	7'	8'
106108	8'	9'
106110	10'	11'
106112	12'	13'
106114	14'	15'
106116	16'	17'
106118	18'	19'
106120	20'	21'
106122	22'	23'
106124	24'	25'



All hose sets greater than 8' in length require additional steering fluid.

The hose kit contains two hoses—high pressure and low pressure—with fittings. The low-pressure hose is 12" longer to allow for uninterrupted travel when connected to the cylinder actuator.

One hose kit is needed per system.

Synthetic Power Steering Fluid

Each Panther XPS Power Steering System comes with specially formulated, fully synthetic power steering fluid.

Part ID	Description
100205	Case Packs: 12 x 1qt bottles



TROLLMASTER PROANGLER



Wireless Precision Throttle Control

Unmatched Trolling Speed Control at Your Fingertips

The **TrollMaster ProAngler** is the latest innovation in wireless throttle control, offering fine-tuned speed adjustments to maximize trolling success. Whether you're navigating shifting currents or dialing in the perfect lure presentation, this system ensures smooth, effortless control.

- PRO Strike Mode** – Instantly increase speed to trigger aggressive strikes from game fish.
- Wireless Remote Control** – Compact, ergonomic remote for easy, on-the-fly adjustments.
- Expanded Battery Life** – Long-lasting performance for full-day fishing trips.
- Universal Compatibility** – Works with most kicker motors (servo hardware sold separately). **TrollMaster ProAngler** remote can be used with **TrollMaster Pro3+** wireless transmitter!



Part ID	Description
TMPROANGLER	Full Kit
TMPROANGLERREM	Remote Only

Kit Contents:

1. **TrollMaster ProAngler** Remote
2. Radio Receiver
3. Servo
4. 2 AA Batteries
5. Detachable Lanyard

Servo Hardware Kits are sold separately. Please see table on page 8.







TROLLMASTER PRO WIRED

Hardwired Throttle Control

Stay Connected. Stay in Control.

For boaters who prefer a hardwired connection, the TrollMaster Pro wired provides seamless throttle control with a direct, reliable link to your kicker motor. Built with a rugged, marine-grade design, it ensures uninterrupted operation in all conditions.

-  **Wired Control for Instant Response** – Hardwired for zero lag in throttle adjustments.
-  **Ergonomic Control Dial** – Simple, intuitive interface for fine-tuned speed adjustments.
-  **Reliable Power Connection** – No need to worry about wireless interference or battery life.
-  **Universal Compatibility** – Works with most kicker motors (servo hardware kit sold separately).

Part ID: **TMPRO**



SERVO HARDWARE KITS

Part ID	Motor Make & HP (Year)	Part ID	Motor Make & HP (Year)
TM200HWKIT	Honda 5, 8, 9.9, 15 (1980-2000)	TM214HWKIT	Mercury 15, 20 (2011-2017) Mercury 15 Remote only (2005-2010) Evinrude 15 (2012-present) Nissan/Tohatsu 20 (2011-present)
TM201HWKIT	Mercury Mariner 9.9, 15 (1990-2004) Yamaha 9.9, 15 (1989-2006)	TM215HWKIT	Suzuki 9.9, 15, 20 EFI only (2014-present)
TM203HWKIT	Mercury 4, 5, 6 (all years) Nissan/Tohatsu 5, 6 (1995-present)	TM216HWKIT	Mercury 15, 20 EFI (2018-present) Remote Throttle or Tiller Tohatsu 9.9, 15, 20 EFI (2018-present) Remote Throttle or Tiller
TM206HWKIT	Yamaha 6 (1999-2012) Yamaha 8 including Hi-Thrust (1999-present) Yamaha 9.9 including Hi-Thrust (2008-present)	TM216HWKITA	Mercury 8, 9.9 EFI (2024 - present)
TM207HWKIT	Honda 8, 9.9, 15, 20 (2001-present)		
TM208HWKIT	Johnson/Evinrude 9.9, 15 (2003-2011) Suzuki 9.9, 15 (2003-2012)		
TM209HWKIT	Mercury 15, 20 Tiller only (2005-2010)		
TM210HWKIT	Yamaha 9.9 including Hi-Thrust (2005-2007) Yamaha 15 including Hi-Thrust (2005-2017)		
TM212HWKIT	Mercury 8, 9.9 (2005-present) Evinrude 9.8 (2013-present) Nissan/Tohatsu 8, 9.8 (2003-present)		

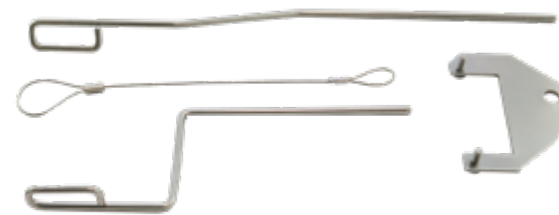

EZ-STEER UNIVERSAL

Ultimate Control for Auxiliary Motors

Seamless Transition Between Main & Kicker Motors

The EZ-Steer Universal System allows you to steer both your main engine and kicker motor simultaneously, ensuring optimal handling when trolling or maneuvering at low speeds. Trusted by boaters for over two decades, EZ-Steer is the go-to choice for auxiliary motor control.



What Sets EZ-Steer Apart?

Simplified Selection & Installation: Redesigned to consolidate 1,000+ SKU combinations into three simple offset sizes—3", 4", or 7".

Universal Fit: Adjustable brackets fit most outboard and sterndrive configurations.

Quick-Release System: No tools required for detachment and reattachment, allowing for easy transitions between engines.

Proven Reliability: Built for rugged use in both freshwater and saltwater conditions.

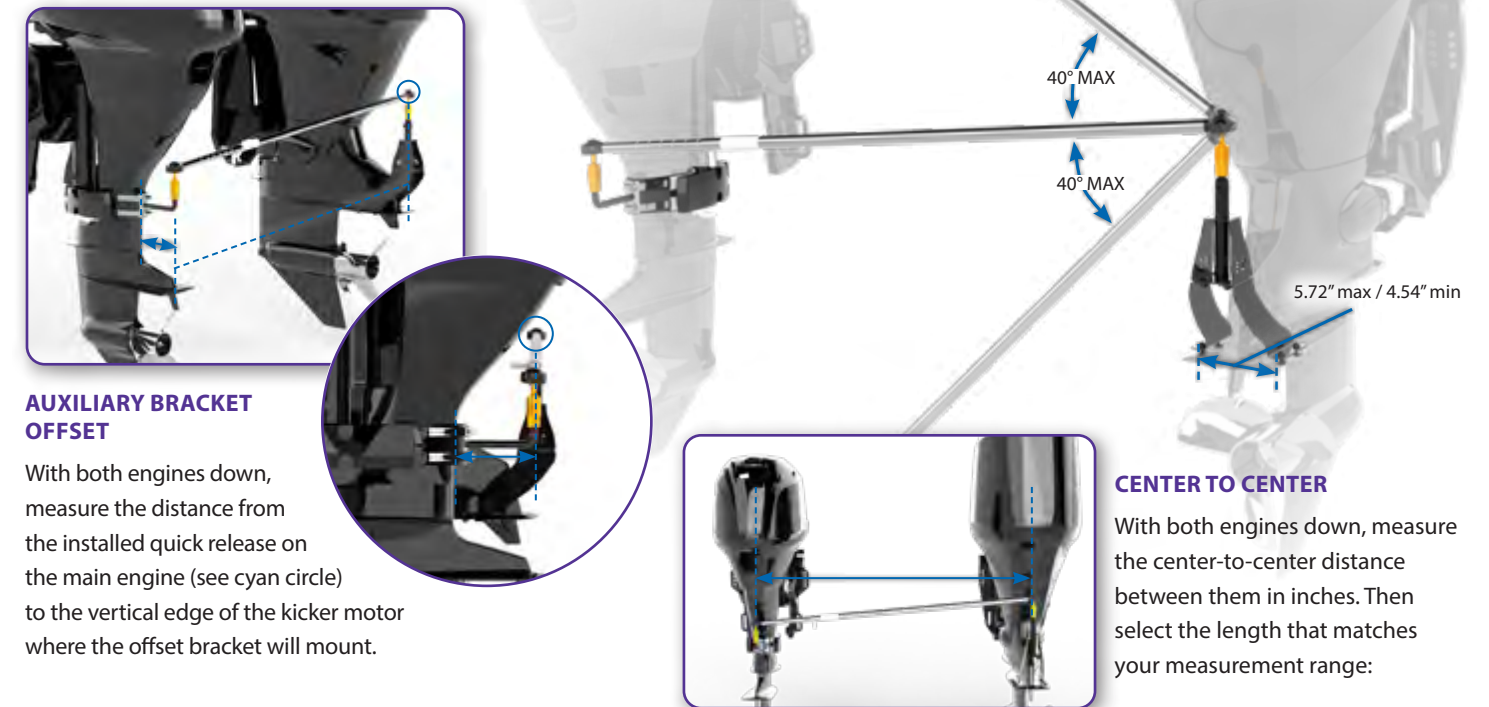

AUXILIARY BRACKET OFFSET

With both engines down, measure the distance from the installed quick release on the main engine (see cyan circle) to the vertical edge of the kicker motor where the offset bracket will mount.

CENTER TO CENTER

With both engines down, measure the center-to-center distance between them in inches. Then select the length that matches your measurement range:

Auxiliary Bracket Offset	Part IDs by Size					
	Center to Center					
	19-22"	23-26"	29-33"	27-28"	39-46"	34-38"
3"	EZUKIT310001	EZUKIT310002	EZUKIT310003	EZUKIT310004	EZUKIT310005	EZUKIT310006
4"	EZUKIT410001	EZUKIT410002	EZUKIT410003	EZUKIT410004	EZUKIT410005	EZUKIT410006
7"	EZUKIT710001	EZUKIT710002	EZUKIT710003	EZUKIT710004	EZUKIT710005	EZUKIT710006

PANTHER KICKER STEERING

Responsive Steering for Auxiliary Motors

Effortless Control for Trolling & Backup Engines

Panther's Kicker Steering Solutions provide electronic and mechanical steering options for auxiliary motors, giving you seamless control over your trolling or backup engine. Whether you're fine-tuning your trolling direction or need a reliable secondary motor steering solution, Panther's kicker steering products help you navigate with ease.

Drive Units

Electro Steer – Wireless-controlled auxiliary motor steering, ideal for hands-free trolling.

- Unique solutions for steering a kicker motor
- Installs on kickers with threaded tilt tube—no drilling required
- Quick installation in minutes
- Requires only inches of space between main motor and auxiliary outboard
- Includes 2-button hand-held remote with 24' cable
- Mounting hardware included



Panther T-5 Drive Unit

Mounts directly to threaded tilt tube. Designed for compact applications.*

A > 14" / B > 7" (see diagram)

T5 4" between motors

Part ID: 550503



Panther T-4 Drive Unit

Mounts directly to threaded tilt tube.*

A > 12" / B > 13" (see diagram)

T4 9" between motors

Part ID: 550103



Panther 100 Drive Unit

The original Electro Steer. For use with motors without threaded tilt tube or when space doesn't allow use of T-4 or T-5. Mounts on boat, forward of motor.*

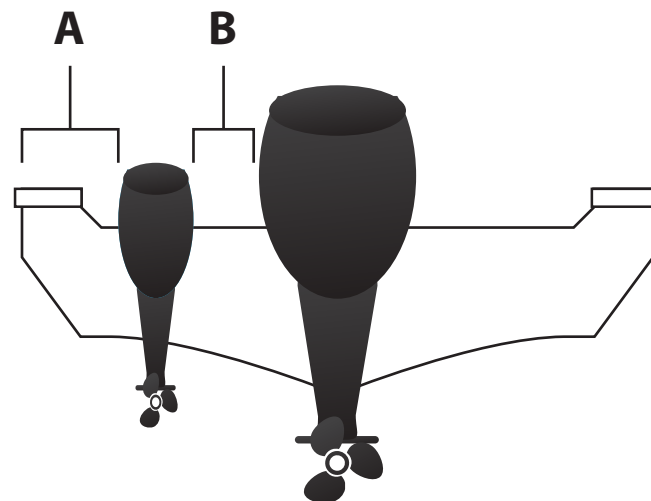

Part ID: 550101A



*TROLLMaster required for throttle control

TIE BAR KITS

A mechanical linkage system connecting main and kicker motors for synchronized control

Description	Part ID	Specification
 Auxiliary Motor Steering Kit	552400	Zinc-plated Steel
	552600	Marine Grade Stainless Steel
 Main Engine Trolling Motor Tie Bar Kit	552700	SeaStar™ Steering
	552900	Uflex™ Steering
 Stainless Steel Drive Bracket	552750	SeaStar™ Steering
	552950	Uflex™ Steering

WIRELESS REMOTE CONTROL

- 50' wireless range
- Receiver powered by standard 12V battery
- Transmitter uses A23-type battery
- Compatible with all Panther steering and Trim & Tilt units
- Universal fit with any 2-prong molded wiring harness
- FCC and IC approved
- Lanyard included
- For use with Electro Steer (not compatible with TROLLMaster)

Part ID: 550105



OUTBOARD MOTOR HARDWARE

SWIM PLATFORM OUTBOARD MOTOR BRACKET

- Adjustable bracket fits most swim platforms
- Compatible with 2 and 4stroke motors up to 20 HP (195 lbs max)
- Black powdercoated aluminum construction
- Adjustable for platform height and motor shaft length
- Includes transom support bar
- Meets ABYC standards
- Includes Panther Safety Cable (550415)

Pontoon Kicker Motor Bracket Kit

- Easy-to-install kit for mounting auxiliary motors on pontoons
- Includes Adapter Bracket (550060) and Swim Platform Bracket (550030) with hardware
- Adapter mounts securely to pontoon frame rails
- Rated for motors up to 20 HP

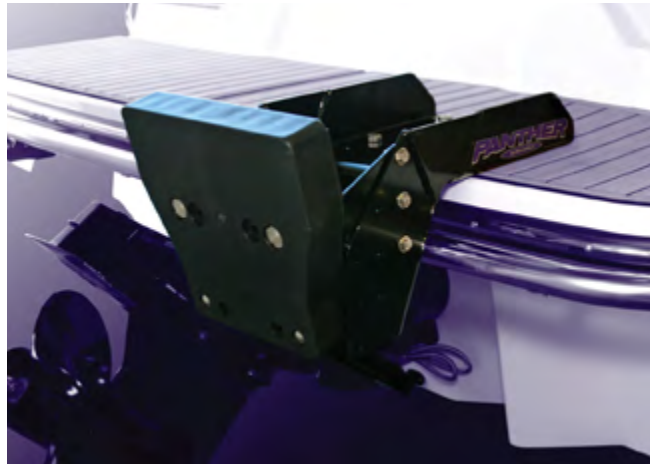

Part ID	Description
550030	Swim Platform Outboard Motor Bracket
550065	Pontoon Kicker Motor Bracket Kit: includes Swim Platform Bracket and Pontoon Adapter Bracket
550060	Pontoon Adapter Bracket Only

FIXED-MOUNT OUTBOARD MOTOR BRACKETS

Vertical, fixed-mount outboard motor bracket. Durable stainless steel construction with heavy-duty polypropylene mounting board



- Includes stainless steel mounting hardware
- Must be used safety cable, now included
- Maximum: 15 HP
- Maximum motor weight: 125 lbs

Part ID: **550024**

MOTOR RESTRAINTS & SAFETY

Stainless Steel Outboard Safety Cable







Braided, stainless steel cable; plastic coated for protection.

Use with all outboard motor brackets to secure the motor to your boat.

Part ID: **550415**



ADJUSTABLE OUTBOARD MOTOR BRACKETS

	Part ID	Setback	Max. HP	Max. Motor Weight	Material	Travel	Adjustment Positions
	550410	Up 8.75" Down 14"	35 HP 4-stroke	263 lbs	Aluminum	10"	5
	550416	Up 9.5" Down 18.5"	35 HP 4-stroke	263 lbs	Aluminum	16"	4
	550012	Up 7.75" Down 14.5"	12 HP 2-stroke	85 lbs.	Aluminum	14"	5
	550010	Up 8.75" Down 14"	20 HP 2-stroke/15 HP 4-stroke	132 lbs	Stainless Steel	11"	4
	550407AL	Up 8.75" Down 14"	20 HP 2-stroke/15 HP 4-stroke	132 lbs	Aluminum	10"	5
	550408SS	Up 8.75" Down 14"	20 HP 2-stroke/15 HP 4-stroke	132 lbs	Stainless Steel	11"	4"
	550021	Up 6.75" Down 12"	20 HP 2-stroke/9.9 HP 4-stroke	115 lbs	Aluminum	11"	5

MOTOR LIFT/SET-BACK BRACKETS

3/8" and 2" Set-Back 5-Degree Reversible Plate



The reversible wedge plate provides 5 degrees of trim or tuck. Its one-piece, cast-aluminum design provides a stable platform for the largest of today's outboards. Standard BIA bolt pattern when used in either the tuck or trim position.

Part ID: 550420



8" Set-Back Bracket

The fixed kicker motor bracket is designed for adjustable mount on the transom. Designed for the heavier 4-stroke motors.

5" height adjustment will accommodate long- and short-shaft motors.

Part ID: 550027



2" Set-Back Plate

This cast-aluminum spacer provides 2" of set-back for bolt-on motors, allowing performance seekers to fine tune their boats. Dipped in zinc-rich primer and powder coated, this solid spacer installs directly to the transom, or adds additional set-back to an existing Jack Plate. A standard BIA hole pattern makes mounting a snap but is drillable for non-standard patterns.

Part ID: 550220



2" Set-Back Static Auxiliary Motor Mount Plate

For mounting auxiliary or kicker motors only. This rugged cast-aluminum plate offers a sturdy and flat mounting area for your kicker motor clamps. When direct-to-transom motor mounting is difficult, our Static Motor Mount Plate provides a flat secure mounting surface for clamp-on or bolt-on kicker motors. Rated for 2- or 4-stroke motors up to 35 HP with a max. weight of 263 lbs. Meets ABYC Standards. Not for main motor applications.

Part ID: 550405



4" Set-Back Plate

A flared shape allows this set-back bracket more transom contact area to reduce stress and improve the motor's stability. The two piece, T-6 heat-treated, hard-coated, anodized aluminum bracket will work with the most powerful main engines. An inexpensive solution to lagging performance while maintaining maximum durability. Pre-drilled hole patterns allow for an extensive range of motor installations.

Rated for marine engines up to 750 HP and 1,500 lb. engine weight.

Part ID: 550240

NEW!

OUTBOARD MOTOR SUPPORT FOR TRAILERING

Ensure the safety of your outboard motor during trailering and transport with Panther's Outboard Support. Durable, adaptable, and designed for convenience, it's the go-to solution for boat owners who frequently move their boats over rough roads or long distances.



Adaptable Design: Internal features adapt to various shaft diameters, ensuring a secure fit for outboards ranging from 50 to 300 HP



Superior Material: Injection-molded polyurethane offers superior durability, consistency, and resiliency compared to rubber



Safety Reminder: Highly visible neon green or vivid purple colour serves as a visual cue to remove the stabilizer before using the motor, preventing accidental damage



Weather-Resistant: Built to withstand harsh conditions, ensuring long-lasting performance



Easy Handling: Ergonomic grip for quick removal and installation

- Fits trim ram diameters of 0.625" to 0.75"
- Length: 4.875"

Part ID	Color
552195	Panther Purple
552195G	Neon Green



TRIM AND TILT

Integral Trim & Tilt

Upgrade your Johnson or Evinrude 20–35 HP 2-stroke (1976–2004) with a bolt-on power trim and tilt system—no motor modifications needed. This unit adds full tilt and trim functionality to engines not factory-equipped, improving performance and convenience.

- **Easy Installation:** Mounts directly to your existing bracket in minutes.
- **Breakaway Safety:** Automatically releases the motor if you strike an underwater object.
- **Reliable Power:** 12V actuator with 12' cable and push-button up/down switch.

Part ID: 550025



Model 35 Trim & Tilt

Built for auxiliary motors up to 35 HP or 150 lbs, this heavy-duty lift supports your kicker in any position—plus, it's the only lift with adjustable setback.



- **Adjustable Setback:** Converts from 8" to 13" useful for inboards, I/O's, jet drives and outboards when over the transom mounting is unavailable.
- **Extended Clearance** - 3" extension bracket for boats that need 16" clearance.
- **Heavy-Duty Design:** Handles kicker motors in any position.
- **Power-Driven Lift:** 12V actuator with 12' cable and push-button control.

Part ID: 550035

Model 40 Trim & Tilt

Ideal for the weekend angler, this heavy-duty aluminum bracket supports 2- and 4-stroke motors up to 150 lbs. Provides automatic trim and tilt with the push of a button.

7" setback. Includes electrical relay and 12V actuator with 12' cable and up/down switch.

Part ID: 550040



Model 435 Fixed Bracket

This fixed motor bracket is designed for those who prefer to use their own strength to lift up their motors. It comes with the adjustable

13" setback feature and is made of 713-alloy aluminum. If lifting your motor becomes a strain, this bracket can be converted to a powerlift by adding our 12 volt actuator (9955005)

Part ID: 550435



Model 55 Trim & Tilt

Compact, heavy-duty lift for 15–55 HP outboards (up to 250 lbs). Great for pontoons, fishing boats, and clamp-on or bolt-through outboards.

Made of cast 713 aluminum with BIA bolt pattern. 7" fixed setback. 12V actuator with push button switch control and cable.

Part ID: 550055



Model 135 Trim & Tilt

An upgrade for aging outboards with failing hydraulic tilt systems. Supports up to 135 HP or 350 lbs.

Provides greater lift range and additional tuckunder to get heavy boats on plane quickly. 7" setback. 12V actuator with 12' cable and switch.

Part ID: 550135



Model 45 Auxiliary Motor Lift

Fast and powerful kicker motor lift with 15" vertical travel. Ideal for high-transom boats with clamp-on motors.

1/4" aluminum construction, powder-coated, stainless steel hardware. 12V actuator system includes wiring (25'), relays, and dash-mounted rocker switch.

Part ID: 550045A



ACCESSORIES

Motor Mount Bolt Bar

Added support for your transom when mounting your main or auxiliary motors. Made from heavy-duty 713 cast aluminum, this bolt bar is chromate dipped and black powder coated for years of like-new-looking support. Uses standard BIA bolt pattern.

- Dimensions: 15" x 2" x 5/8"
- C-C: 12-7/8"

Part ID: 559100



Pro-Strap Kicker Tie Down

Provides hands-free, heavy-duty retention for the Model 35. Use to prevent motor bounce.

Part ID: 551500



Engine Mount Washers

Designed to support outboard engines with transom mount bolts. Perfect for OEM or after-market use. Constructed of heat-treated, hard-coated, anodized aluminum. Sold in pairs.

Part ID: 559150

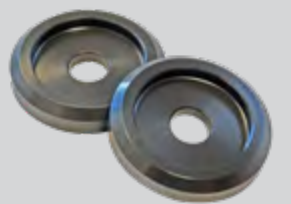
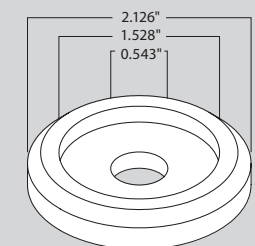



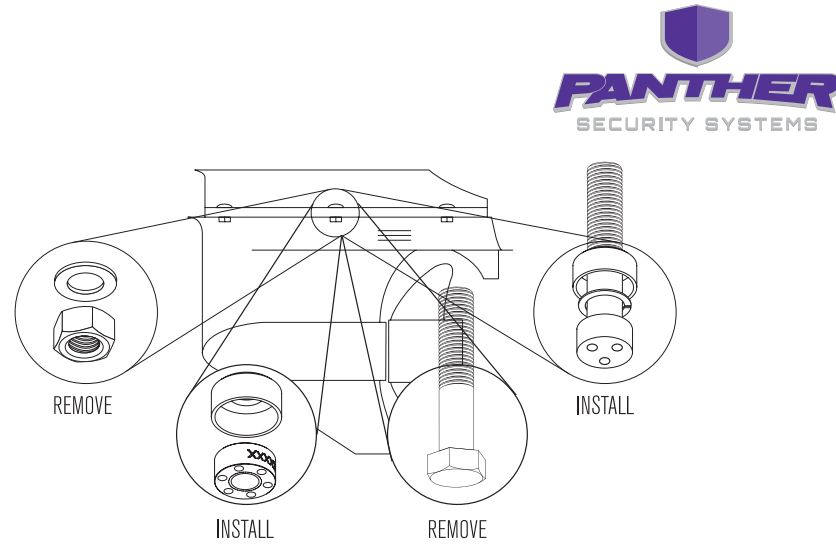

LOWER UNIT LOCKS

Protect your outboard investment with Panther's Lower Unit Locks. Made from marine-grade stainless steel, these tamper-resistant locks install quickly and easily—no drilling or modifications required.

Remove the existing nut, washer or bolt and **replace** with the security nut or bolt and bell washer and rest easy—your lower unit is now secure!



Motor	HP / Description	Engine Configuration	Part ID
	150 - 300 HP	Single	758410
		Twin	758420
		Triple	758430*
	Verado 150 - 350 HP, Optimax 115 - 250 HP	Single	758310
		Twin	758320
		Triple	758330*
	200 - 300 HP	Single	758710
		Twin	758720
		Triple	758730*
	Yamaha 200 HP Plus, All Honda	Single	758610
		Twin	758620
		Triple	758630*
	Yamaha	Short Bolt 150 HP and under - 20" Shaft	Single 758510
		Twin	758540
		Short Bolt 150 HP and under - 25" Shaft	Single 758520
		Twin	758550*
		150 HP and above - 30" Shaft	Single 758531
		Twin	758532
Triple	758533		

*Photo shown

OUTBOARD LOCKS



Panther Outboard Lock

Heavy carbon steel design and fits Turnbuckle mounted engines. It has a recessed, solid brass lock and noise dampeners that reduce rattle.

Suitable for **freshwater** use only.

Part ID: **758000**



Heavy-Duty Outboard Lock

This Outboard Lock fits Turnbuckle design and has anti-drill protection. It has polished, marine-grade stainless steel and noise dampeners that reduce rattle. The two security keys cannot be duplicated.

Part ID: **758201**

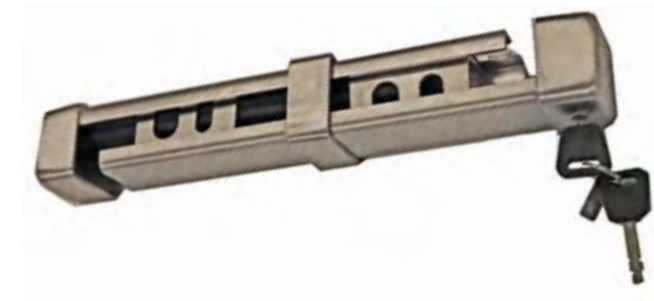

High-Security Outboard Motor Lock

Built from marine-grade stainless steel, this lock features anti-drill protection and fits engine bolts up to 1/2" (12 mm). Includes two non-duplicable security keys for maximum theft resistance.

Part ID: **758101**





King Pin Anchor Systems

SET the pin to STOP the spin!

Designed to mount on the bow or transom, King Pin Anchors are a great alternative—or complement—to expensive power actuator poles for keeping your boat from spinnin' in the wind.

KING PIN ANCHORING SYSTEMS

A convenient, shallow-water anchoring system for a quick, no-maintenance way to hold your boat in position in shallow water without heavy anchors and wet, cumbersome ropes. Ideal for precision bait presentations, especially in windy or high-current conditions. With no power, switches or wires, King Pin is the perfect complement or alternative to power-actuated pole anchors. Available in bow or transom mount with a wide range of anchor pole selections.

Features

King Pin Signature Anchor Poles

2-piece poles feature a pool-cue-style stainless steel butt collar for quick breakdown and easy storage or transport. Constructed of 3/4" diameter, high-impact fiberglass. Equipped with molded foam grips and stainless steel tips to protect the pole while allowing easy bottom penetration. Rubber storage clips with mounting screws included. 2-piece poles are of equal length. (8', single-piece pole also available.)

Clear anodized or black powder-coated aluminum. Mounting hardware included.

Quick-Release Bow & Transom Mount Brackets

With a quick pull of the plunger pin and a short twist, the bracket can be removed leaving only the mounting plate for a clean, obstacle-free deck or transom. Includes integrated O-rings eliminating the need for sealant. Bow mounts are available in 3" or 6" rise for safe and easy gunnel clearance. Transom mounts are available in 2.5" and 5" setback.

Signature Pole Lock

All brackets are equipped with a proprietary, integrated pole lock. Just flip the lever to secure the pole in the bracket. No loose parts that can fall in the water.

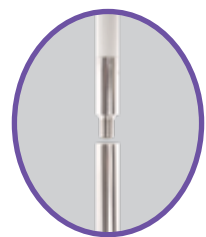

2-Piece Poles

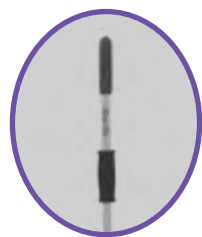

Molded Foam Grips



Proprietary Pole Lock



Quick-Release Mounting Plate



Stainless Steel Pole Tip

Quick-Release Bow Mount Bracket

Part ID	Rise	Finish
KPB30A	3"	Clear Anodized
KPB30B		Black Powder Coat
KPB60A	6"	Clear Anodized
KPB60B		Black Powder Coat



Transom Mount Bracket

Part ID	Setback	Finish
KPS25A	2.5"	Clear Anodized
KPS25B		Black Powder Coat
KPS50A	5"	Clear Anodized
KPS50B		Black Powder Coat



Quick Release Transom Mount Bracket

Part ID	Setback	Finish
KPSQ50A	5"	Clear Anodized
KPSQ50B		Black Powder Coat



Universal Engine Mount Plate

For engine-mount application, combine only with 2.5" Transom Mount Bracket.

Part ID: KPMMP



Spare Bow Mount Base Kit

Dimensions: 4" x 6"

Part ID	Finish
KPBQCKA	Clear Anodized
KPBQCKB	Black Powder Coat



Two Piece Anchor Poles

Part ID	Length	Finish
KPP802W	8"	White
KPP802B		Black
KPP100W	10"	White
KPP100B		Black
KPP120W	12"	White
KPP120B		Black



Spare Pole Clips

Durable rubber clips securely hold 2-piece poles for easy storage and access.

Part ID: KPPC



ANCHORING & MOORING ACCESSORIES

Water Spike Anchor

Made of 1/4" plated steel. Unmatched holding power. Completely collapsible for compact storage and incredibly lightweight.

Part ID	Boat Size	Anchor Weight
559200	Up to 16'	7 lbs.
559300	Up to 22'	10 lbs.
559400	Up to 35'	13 lbs.



Shore Spike

Quickly anchor your boat or personal watercraft in shoreline materials including sand, clay or firm soil. Securely holds boats up to 26'.

- Dimensions: 1/2" x 4" x 36"

Part ID	Description
559500	Zinc Plated Carbon Steel
559600	304 Solid Stainless Steel



Panther Anchor Rope

Panther anchor rope is manufactured with the outdoorsman in mind. Made from heavy-duty 3/8" blue polypropylene, it has an amazing tensile strength of 2,800 lbs. Comes packaged with a no-tie rope cleat and snap hook. Available in both 50' and 100' lengths.

Part ID	Length
757000	50'
757010	100'



Panther Portable Rope Cutter

Lightweight and easy to use, this 120V rope cutting gun makes fast, clean cuts in all types of synthetic rope, line, and strapping. Perfect for boats, campers, or home use. Includes a 4' power cord. Replacement blades available.

- Weight: 1.5 lbs
- Dimensions: 6" H x 6" L x 2" D

Part ID	Description
757060B	Portable Rope Cutter
757061	Replacement Blades



The Original Gripper Rope Cleat

Secure rope up to 3/8" (or 1/2" with models 558400 and 558500) without tying knots. Perfect for boats, docks, trailers, and more—holds up to 200 lbs with a simple wrap-and-lock design.



- Sold in 2-packs

Part Id	Finish	Size
558100	Black Nylon	3"
558400	Zinc Plated	3"
558200	Chrome Plated	3"



Happy Hooker Mooring Aids

Makes picking up moorings a snap. This unique product allows the user to easily pass a rope, mooring line, dock line or cable through an eye hook, ring, bow eye or mooring buoy eye and retrieve, all in one simple motion. Easily fastens to most any type of extension pole with a bolt or hose clamp. (Pole not included.)

	Part ID	Use	Max Structure Diameter	Support Pole Diameter	Material
	85B203STN	Heavy Duty	4"	1.12"	Stainless Steel
	85B203MAR	Light-use, recreational	2"	1"	Glass Reinforced Plastic



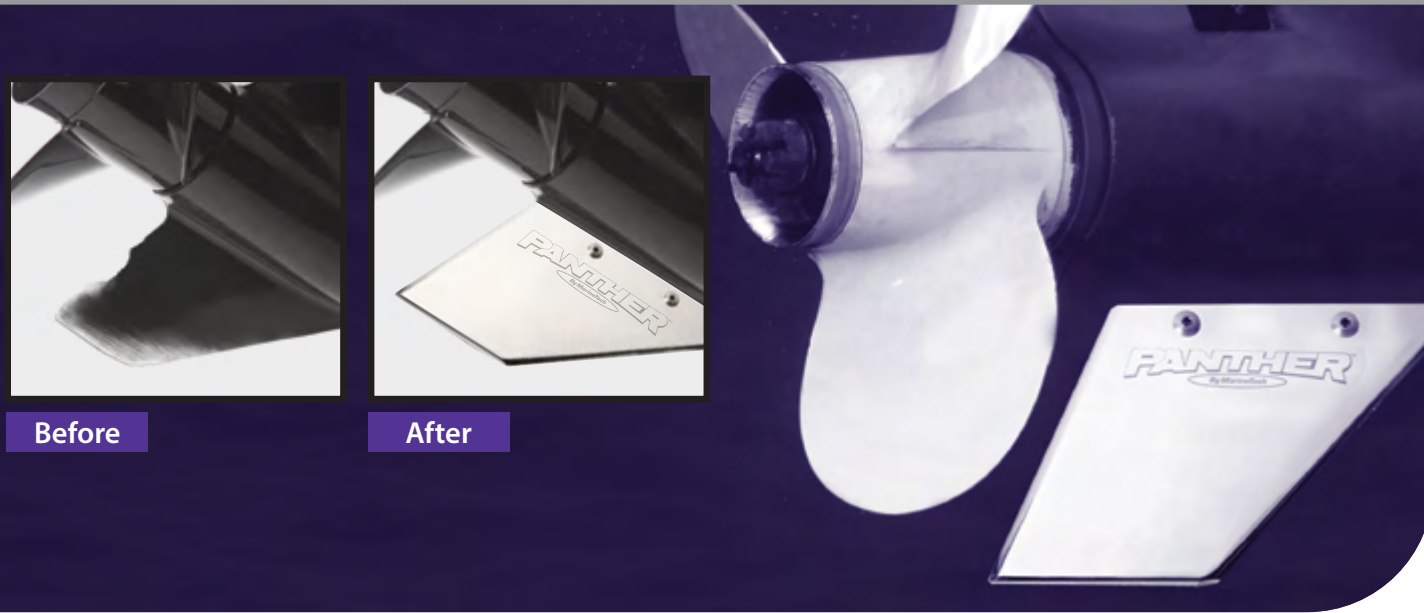

Before

After

The Ultimate Stainless Steel Skeg Protection

Whether you're looking to protect your new skeg, repair your damaged one, or just add some shine, the 316 marine-grade, stainless steel construction Safe-Skeg is brilliantly polished and ready to install.

Kits include: Mounting hardware, instructions, Allen wrench and Loctite 262.

Motor	HP/Description	Stroke	Year Range	Part ID
Evinrude/Johnson Outboard	150-175-185-200-225	2	1986-2003	35SS630
	150 DBX & DPL (E-TEC)	2	2004-Present	35SS630
	225-250 DCX, DCZ, DPX (E-TEC)	2	2004-Present	35SS630
	175-200 DPL, DSL Blue (E-TEC)	2	2004-Present	35SS630
	90-100-115-120-140	2	1980-2001	35SS635
	60-70	2	1984-2002	35SS640
	40-50 & 60 (E-TEC)	2	1984-2013	35SS640
	150-175-200 DCX & DPX (E-TEC)	2	2004-Present	35SS670
	225-250 DPL Blue (E-TEC)	2	2004-Present	35SS670
	75 & 90 (E-TEC)	2	2002-2008	35SS675
	100-115	2	2003-2005	35SS675
	115 HP, DBX, DCX, DPX (E-TEC)	2	2006-2008	35SS675
	60-70-90-115-140 (by Suzuki)	4	1999-2003	35SS680
	40-50 (by Suzuki)	4	1999-2003	35SS710
Force Outboard	70-90 (by Mercury)	2	1998-2002	35SS625
	70-75	2	1991-1997	35SS650
Honda Outboard	75-90-115	4	1995-2007	35SS625
	35-40-45-50-90	4	1991-Present	35SS650
	135-150-200-225	4	2004-Present	35SS685
	115	4	2010-Present	35SS685
MerCruiser Inboard/Outboard	Pre Alpha #1 Drives		1973-1984	35SS600
	Alpha 1 Drives		1985-1990	35SS605
	Alpha 1 Generation II Drives		1991-Present	35SS610
	Bravo 1 & 3 Drives		1990-Present	35SS615

Motor	HP/Description	Stroke	Year Range	Part ID
Mercury/Mariner Outboard	135-150-175-200 Optimax	2 & 4	1978-2011	35SS620
	225	2	1978-1995	35SS620
	50-60 (Big Foot)	2 & 4	2003-Present	35SS625
	70-75-80	2 & 4	1984-Present	35SS625
	70-90-100-115-125 Optimax	2 & 4	1983-Present	35SS625
	40-50-60	2	1986-2002	35SS650
	200-225 Optimax	2	1996-2004	35SS660
	225-250-275-300 Verado	4	2005-Present	35SS660
Mercury Outboard	40-50-60	2 & 4	2003-Present	35SS710
	90-115 Optimax	4	2012-Present	35SS620
Mercury Outboard	Verado & Optimax 150-300	4	2012-Present	35SS715
	70-90-115-120-140	2	1993-2010	35SS625
Nissan Outboard	35-40-50	2	1993-2010	35SS650
	Cobra V6 & V8 Cylinder Drives		1986-1994	35SS630
OMC Inboard/Outboard	Cobra 4 Cylinder Drives		1986-1994	35SS635
	300	4	2009-2011	35SS630
Suzuki Outboard	150-175-200-225	2	1986-2002	35SS645
	150-175-200-225	4	2003-Present	35SS645
	250SS & 300	4	2006-2011	35SS645
	40-50-60-70	4	2003-Present	35SS650
	90-115-140	4	2003-Present	35SS680
	70-90-115-120-140	2	1993-Present	35SS625
Tohatsu Outboard	35-40-50	2	1993-Present	35SS650
	DP Drives (Dual Prop)		1996-2007	35SS655
Volvo Penta Inboard/Outboard	SX Drives (Single Prop)		2007-Present	35SS655
	SX Drives (Single Prop)		1995-2006	35SS665
	60-70-80-90-100	2 & 4	1998-2001	35SS625
Yamaha Outboard	115-130	2	1984-2002	35SS645
	150	2 & 4	1984-Present	35SS645
	175-200-225-250	2	1984-2002	35SS645
	350	4	2009-Present	35SS645
	40-48 & 50-85CV	2	1984-2000	35SS650
	115-130	2	2003-Present	35SS690
	115-130	4	2000-Present	35SS690
	200-225-250-300	2 & 4	2003-Present	35SS695
	60-70-80-90-100	2 & 4	2002-Present	35SS700
	40-50	2 & 4	2001-2011	35SS705
Yamaha Inboard/Outboard	V Max SHO 200-225-250	4	2013-Present	35SS720
	3.0 L thru 5.7 L		1989-1993	35SS645
Replacement Bolt Kit				35SSKIT1

ELECTRONICS MOUNTS

Upgrade Your Fishing Experience!

Mount your electronics with confidence and free up deck space. Panther Electronics Mounts fit most major brands and make it easier to operate your foot pedal—perfect for pros and weekend anglers alike.

NEW!

Dual Electronics Mount

New for this season, the Panther Dual Electronics Mount is built for anglers who run two screens side-by-side. Whether you're fishing tournaments or just want better visibility, this rugged mount is designed to deliver serious performance.

- Holds two units up to 12"
- Spans over recessed foot-control pedals to maximize space
- Improves visibility and workflow
- Marine-grade, powder-coated aluminum construction



Part ID

Description



954400DM

Complete Dual Mount Assembly



954400DMKIT

Dual Mount Adapter Kit
(for use with 954400 Flat Base Mount)

Flat Deck Mount Electronics Bracket

A compact, durable mount for fishfinders and GPS/sonar units up to 16". Spans over most recessed foot-control pedals, freeing up space and improving pedal access. Works with the Dual Mount Adapter Kit for easy upgrades.

- Fits units up to 16"
- Marine-grade, powder-coated aluminum
- Spans most recessed pedals
- Inside span: 14.1"

Part ID: 954400



Angled Deck Mount Electronics Bracket

Ideal for decks with limited space in front of the foot pedal. The 22.5° angled bracket improves aft foot clearance while keeping your unit firmly in view.

- Fits units up to 16"
- 22.5° angled plate for better pedal clearance
- Powder-coated, marine-grade aluminum
- Inside span: 14.1"

Part ID: 954200



Dash Mount Electronics Bracket

Securely mount electronics up to 12" to most flat dash panels. Offers better visibility and adjustment compared to flush mounting.

- Fits most 12" units
- Mounts to flat console panels
- Marine-grade, powder-coated aluminum
- Overall length: 10.6"

Part ID: 954000



RECESSED FOOT-CONTROL TRAY

Fish in Comfort. Streamline Your Deck.

Fish longer with less strain. The Panther Recessed Foot-Control Tray levels your trolling motor pedal for a more natural stance, reducing back and foot fatigue. The flush-mount design adds a clean, professional look to any deck and fits all Minn Kota and MotorGuide foot-control motors.

- Forward-tapered for faster drainage
- Built-in drain tube (3/8" ID x 8' vinyl)
- Durable, UV-resistant, high-density polyethylene
- Color-molded—no paint to chip or fade
- Easy installation with template and hardware included
- Fits any boat brand and all Minn Kota & MotorGuide foot pedals
- Inside Dimensions: 9.5" W x 13.5" L x 4.5" D

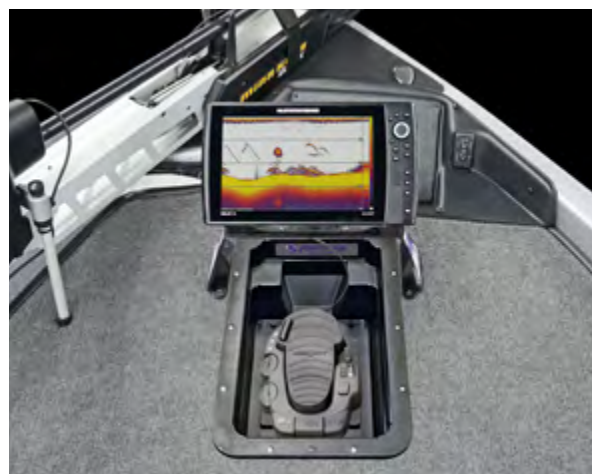

Part ID	Description
559815	Foot Tray
559825	Foot Tray Insert
559800	Foot Tray with Insert

MULTI-MOUNTS & TROLLING MOUNTS

Our all-black mounts deliver a sleek, modern look that pairs perfectly with today's electronics. Built for performance and style, they bring a clean, pro-level finish to any setup.

Part ID	Description
---------	-------------



950210 Trolling Motor Mounts



950304 4" Aluminum Multi-Mount



950308 8" Aluminum Multi-Mount

Part ID	Description
---------	-------------



950310 10" Aluminum Multi-Mount



950305 5" Nylon Multi-Mount



950325 5" TROLLMaster Mount

QUICK-RELEASE ADAPTER

The quick release allows the user to quickly and effortlessly remove expensive electronics from the boat for safe storage. With just a push of the plunger pin and a quick twist, the unit is protected.

Constructed of corrosion-resistant, fiberglass-reinforced polypropylene and stainless steel, the quick-release is lightweight and suitable for fresh or saltwater environments.

- 3-3/4" D x 15/16" H
- Stainless steel mounting hardware included
- Not recommended for use with electronics weighing over 5 lbs.
- For use with Panther electronics mounts only

Part ID: 950500



SPARE BASE PLATES

- 2-3/4" diameter

Part ID	Description
950503	Anodized aluminum
AP50003NYL	Nylon composite: fits 95035 & 950325



ROD HOLDERS

Engineered for serious fishing, these corrosion-resistant rod holders feature 25° and 45° Posi-Lock notches and a full 360° of locking positions. Made from stainless steel and black anodized aluminum, each holder fits rods up to 1-3/4" in diameter and removes easily for storage—perfect for fresh or saltwater use.

Part ID	Socket Length
---------	---------------



950700 7-3/4"



950800 10"

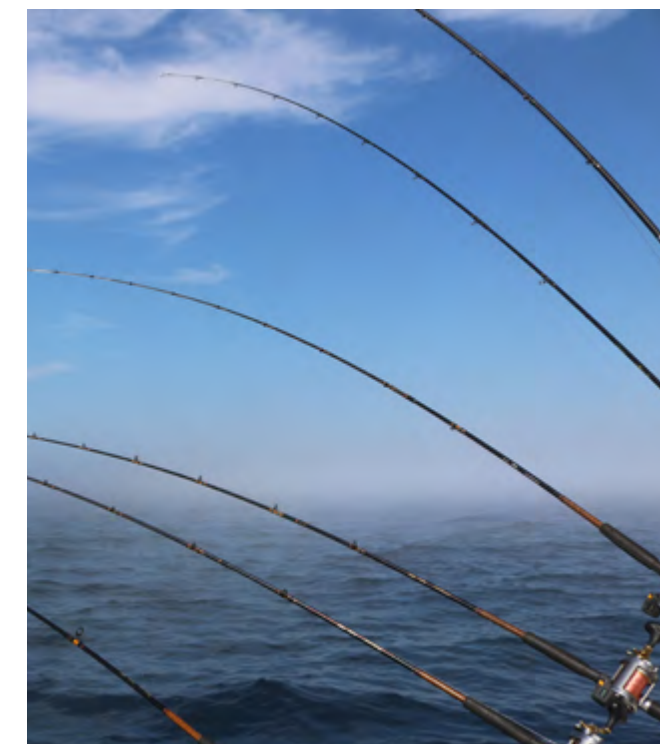

FLUID EXTRACTORS

Pro Series – Heavy-Duty Extractors

Built for serious shop use or mobile service. Rugged construction, large capacity, and a see-through container make fluid changes faster and cleaner. Includes a decompression valve for easy pressure release, a foot board for stability, and a pour spout for mess-free disposal. **Suitable for: Engine oil, gear lube, brake fluid, coolant, water, and more.**

Note: Not for use with flammable or corrosive fluids.

Part ID	Product Name	Capacity	Operation	Description
756015P	Pro Series Pneumatic/Manual Oil Extractor	15 Liters	Pneumatic or Manual	Connects to compressor or used manually. Includes airinlet control valve, quick exhaust, pressure balancer, check valve, and 48" hoses with fittings.
756015	Pro Series Manual Oil Extractor	15 Liters	Manual Only	Same as 756015P but manual operation only. Not pictured.
7560V	Pro Series InLine Valve	—	—	Brass valve for use with 756015P. Holds vacuum without constant air supply. Installs in extraction tube.
756065	Pro Series Manual Oil Extractor	6.5 Liters	Manual Only	Midsized extractor for smaller jobs. Includes extralong 48" hoses with fittings.
756099	Pro Series Replacement Hose Kit (not pictured)	—	—	Replacement hose kit for 756015, 756015P, and 756065.



DIY Series – Compact Extractors

Simple, efficient oil extractors for quick clean changes. Prime in seconds. See-through container shows fluid level. Flexible, non-kinking metallic tubes.

Note: Not for use with flammable fluids.

Part ID	Product Name	Capacity	Best For	Key Features
756060	DIY Series Oil Extractor	6 Liters	Most boaters	Large capacity, see-through container, fast priming, flexible metallic tube
756025	DIY Series Oil Extractor	2.5 Liters	Small engines (up to 50 HP), sailboats	Compact size, ideal for tight spaces, same features as 756060 in smaller form



ENGINE FLUSHING & MAINTENANCE

Flush Buddy

Easy inboard motor flusher—perfect for maintenance, winterizing, or running your engine out of the water. Connects to a garden hose and fits over the water intake.

- Adjustable from 19" to 30-1/4"
- Durable aluminum and heavy-duty rubber construction

Part ID: 755000



TRAILERING & TRANSPORT SUPPORT

Outboard Motor Support for Trailering

Protect your 50 to 300 HP outboard during transport

- Fits trim ram diameters: 0.625"–0.75"
- Length: 4.875"
- Durable injection-molded polyurethane Adapts to various shaft sizes for a secure fit
- Bright neon green for easy visibility and safety
- Ergonomic grip for quick installation and removal

Part ID	Color
552195	Panther Purple
552195G	Neon Green



Adjustable Motor Support

Universal design with bolt-on and over-the-roller brackets. Adjustable from 34" to 46". Includes two rubber straps.

Part ID: 552100



Outboard Stabilizer Clips

Snap over hydraulic steering and cylinder rods to keep your outboard centered during transport. Fits most engines from 1997 and newer.

- Includes 2 per pack.
- Dimensions: 4" long, 3/4" ID

Part ID: 552190



Adjustable Transom Saver

Extends from 28" to 59" to reach under-boat trailer crossbars. Fits most trailer brands and includes an easy-to-install bracket. Quick to remove for loading and unloading.

Part ID: 551900



PONTOON ACCESSORIES

Gate Hinge

Built-in washers reduce noise, rattle, and wear. For pontoon gates that lift up and out of the door stop.

- Dimensions: 2.75" H x 2.5" W x 0.41" D

Part ID	Gate Side
250203A	Port (shown)
250204A	Starboard



Door Stop

Prevents gate rattle during use. Easy one-screw installation (screw not included).

- Dimensions: 1.875" H x 1.688" W x 1.53" D
- Fits 1-1/4" rails.

Part ID	Side
250206	Port (shown)
250207	Starboard



Gate Support

Reinforce your pontoon's rail system with strong, lightweight aluminum supports. Ideal for adding stability anywhere along the fencing. Mounting hardware not included.

- Dimensions: 9.625" H x 3.875" W x 1.125" D

Part ID	Gate Side
250210	Left (shown)
250211	Right



Gate Anti-Pinch Guard

Helps prevent finger pinching in pontoon gates. Easy to install between the gate and rail. Fits 1-1/4" rails and mounts to both gate and rail.

Part ID: 250208



MOUNTING HARDWARE

Nylon Socket Bushings

Reduce friction and noise while rowing. Converts 5/8" oarlock sockets to 1/2".

- Size: 5/8" to 1/2"

Part ID: 85G814MAR



Should your unit ever require service please do not return the product to your dealer.

Instead please call 1-877-938-9766 for special instructions on shipping and handling. Be sure to call between 9 00 AM and 5.00 PM (Pacific Time) Monday through Friday. If the service required is covered by the warranty, it will be repaired or replaced as described below. If the service required is NOT covered by warranty replacement parts are available for purchase and paid for by a major credit card.

The warranty coverage on this equipment is limited to the terms set forth below:

CMP Group LTD. warrants this product to be free of defects in material and workmanship for a period of ONE (1) YEAR from the date of original retail purchase. Positive proof of date of purchase is required for warranty service. If the service required is covered by warranty, you must obtain a Return Authorization number from CMP Group . The unit will be repaired or replaced with new or factory rebuilt parts at no charge. The defective components must be returned to the address specified, with shipping charges prepaid. Be sure to include your name, address, telephone number and a copy of the sales receipt showing the date of original retail purchase. All sales receipts are subject to verification.

This warranty does not apply if the unit has been damaged by accident, abuse, misuse, poor installation or misapplication, or if it has been modified from its original condition, or if any serial number has been removed or defaced or altered. This warranty does not cover any expense to remove or reinstall the unit or any of its components. If a returned unit is not covered by warranty, the sender will be notified and given an estimate of the charges to repair or replace the unit together with the return shipping charges.

This warranty does not cover special, incidental, or consequential damages resulting from any breach of warranty, or under any other legal theory, including but not limited to damage to or replacement of other equipment and property. The warranty and remedies set forth are exclusive and in lieu of all others, whether oral or written, express or implied. Due to the special and unique conditions that may exist in each application, the manufacturer specifically disclaims any and all implied warranties of merchantability and fitness for a particular purpose. No dealer, agent or employee is authorized to make any modification, extension or addition to this warranty.

Some states do not allow exclusion of incidental or consequential damages, so the above exclusions may not apply to you. This warranty gives you specific legal rights, and you may also have other legal rights, which may vary from state to state.

PANTHER[™]

panthermarineproducts.com



ezsteer.com

*TROLL***Master**[™]

trollmasters.com

CMP 
CMP Group Ltd.

7733 Progress Way
Delta, BC, V4G 1A3, Canada
Tel: 1-877-938-9766 | Fax: 1-604-952-2650
cmpgroup.net